

KÄRCHER



LISTINO PREZZI 2022

CONSUMER PRODUCTS

Home Improvement - Prodotti per la pulizia della casa e del giardino

Validità 1° Maggio 2022



INDICE

OUTDOOR CLEANING

Idropulitrici	8
Spazzatrici manuali	9
Manutenzione spazi esterni	9
Accessori	10
Detergenti	14

HOME CLEANING

Aspiratori	22
Aspiragocce e Lavavetri a batteria ricaricabile	23
Lucidatrice	23
Elettroscopa a batteria ricaricabile	23
Lavapavimenti	24
Pulitori a vapore	24
Accessori	25
Detergenti	31

GARDEN

Elettropompe	33
Irrigazione	35

PRODOTTI A BATTERIA

Prodotti a batteria 18V	44
Prodotti a batteria 36V	45
Caricabatterie	46
Accessori	47



TECNOLOGIA PROFESSIONALE AL VOSTRO SERVIZIO

Utilizziamo la stessa cura con cui liberiamo il monte Rushmore dallo sporco, anche sulle superfici di casa vostra. Tutti i nostri prodotti, sia outdoor che indoor, sono dotati di caratteristiche peculiari di **derivazione professionale**.

Basti pensare al **motore raffreddato ad acqua** (WCM) o al **dirt blaster** (ugello rotante ultra efficace) disponibile sulle nostre idropulitrici per un pulito perfetto e senza fatica.

Anche gli aspiratori solido liquidi sono dotati tecnologia professionale come il **filtro piatto** che garantisce la massima efficienza e potenza d'aspirazione.

Per la pulizia dei pavimenti, proponiamo la tecnologia dei rulli **controrotanti** di FC7, la nostra lavapavimenti che lava e rimuove qualsiasi tipo di sporco in una sola passata.

IDROPULITRICI KÄRCHER RAFFREDDATE AD ACQUA

LE UNICHE CHE DURANO 10 VOLTE DI PIÙ*.

PERCHÈ LE IDROPULITRICI KÄRCHER SONO SUPERIORI.

Perché sono le uniche sul mercato domestico dotate di **motore raffreddato ad acqua** (WCM = Water Cooled Motor).

Questa tecnologia di **derivazione professionale** garantisce **maggiore affidabilità e durata nel tempo**. In più è una tecnologia che garantiamo per **3 anni!**



DURANO 10 VOLTE DI PIÙ*

Il motore con raffreddamento ad acqua genera un campo elettromagnetico che evita l'usura dei componenti.

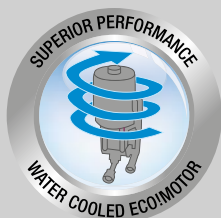

LAVANO SENZA INTERRUZIONI (NO-STOP)

Il raffreddamento d'acqua evita il surriscaldamento del motore, garantendo un utilizzo in continuo.



PIÙ SILENZIOSE*

Fino al 50% di silenziosità in più grazie a 3.000 giri rispetto ai 20.000 giri delle idropulitrici tradizionali.

*rispetto alle idropulitrici con motore raffreddato ad aria.

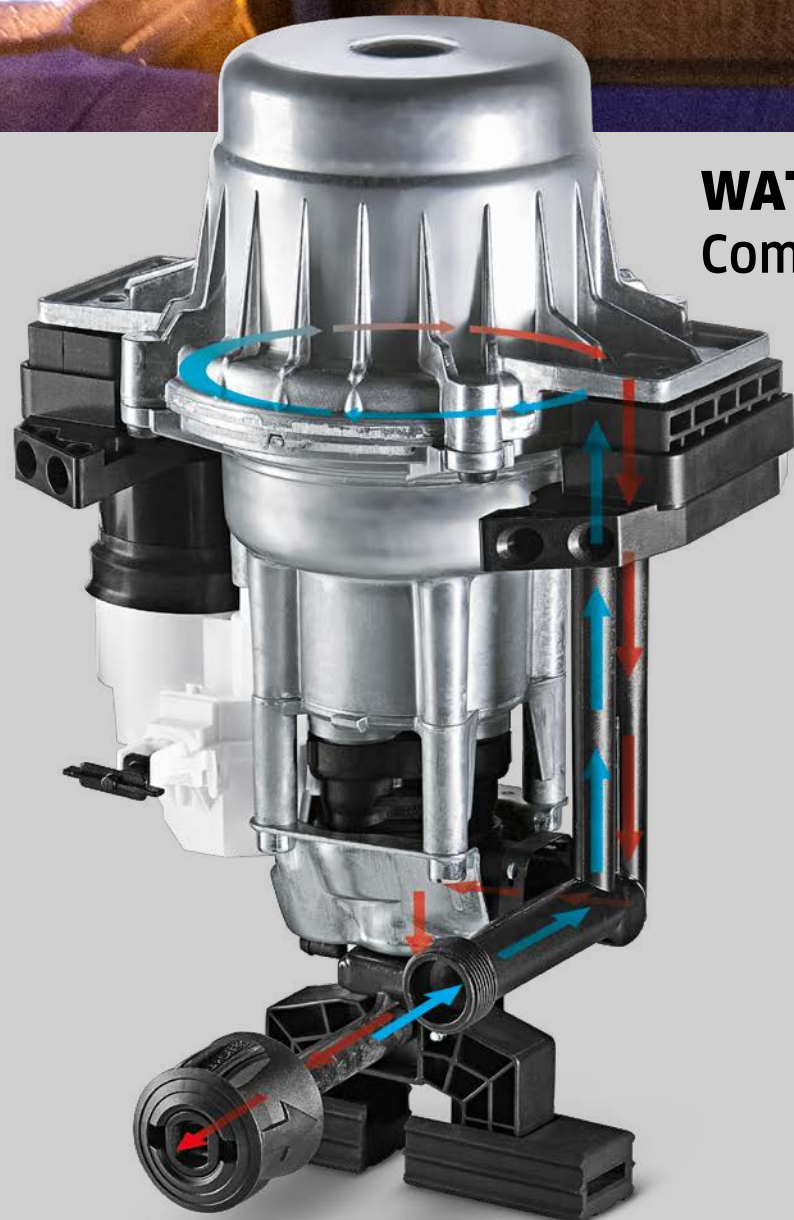

WATER COOLED MOTOR (WCM) Come funziona

L'acqua che avvolge il motore ha una duplice funzione:

- raffredda il motore evitando surriscaldamenti
- si riscalda e fuoriesce in temperatura dalla lancia migliorando i risultati di pulizia.

Flusso del liquido raffreddante

- **BLU**
acqua fredda refrigerante
- **ROSSO**
acqua in uscita riscaldata dal motore

DIRT BLASTER

L'UGELLO ROTANTE ULTRA EFFICACE!



VANTAGGI

Dirt blaster è l'ugello rotante mangia-sporco brevettato da Kärcher. Grazie ad una **larghezza di abrasione doppia** rispetto alla concorrenza permette di avere:

- ▶ più pulito in meno tempo
- ▶ più efficace contro lo sporco ostinato
- ▶ 60% di potenza in più rispetto all'ugello standard.



Dirt blaster: efficace in tutte le situazioni di sporco difficile



Scale esterne



Utensili da giardino



Muretti incrostati

IL TOP DELLA TECNOLOGIA KÄRCHER

DA OGGI PRESENTE SU
3 GAMME COMPLETE E
DIFFERENZIATE

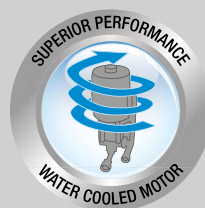

POWER & SMART CONTROL
Massima potenza e
controllo per un uso
specifico in ogni situazione.



X RANGE

La superiorità della
tecnologia Kärcher da
ora a portata di tutti.



COMPACT

Massima potenza in
dimensioni compatte
per un trasporto
facile ed immediato.

OUTDOOR CLEANING

IDROPULITRICI A FREDDO

LINEA SMART & POWER CONTROL



Modello	Codice	Codice EAN	Pressione Max (bar)	Potenza (W)	Portata (l/h)	Pallet	LP 2022*
K 7 Smart Control Home	1.317-203.0	4054278787053	195**	3000	600	12	635,00
K 7 Smart Control	1.317-200.0	4054278604107	195**	3000	600	12	570,00



K 7 Power Home	1.317-151.0	4054278961217	180	3000	600	12	560,00
K 7 Power	1.317-150.0	4054278961224	180	3000	600	12	500,00



K 5 Power Control Home	1.324-553.0	4054278786384	145	2100	500	8	440,00
K 5 Power Control	1.324-550.0	4054278618265	145	2100	500	12	375,00



K 4 Power Control Home	1.324-033.0	4054278785875	130	1800	420	8	335,00
K 4 Power Control	1.324-030.0	4054278618227	130	1800	420	12	265,00



K 3 Power Control Home	1.676-103.0	4054278786575	120	1600	380	18	205,00
K 3 Power Control	1.676-100.0	4054278605166	120	1600	380	18	160,00



K 2 Power Control Home	1.673-603.0	4054278796116	110	1400	360	18	150,00
K 2 Power Control	1.673-600.0	4054278604046	110	1400	360	24	110,00

LINEA X RANGE



K6 X range (WCM)	1.168-508.0	4054278937328	160	3000	600	12	375,00
------------------	-------------	---------------	-----	------	-----	----	--------



K 5 X range (WCM)	1.180-633.0	4039784729650	145	2100	500	12	270,00
-------------------	-------------	---------------	-----	------	-----	----	--------



K 4 X range (WCM)	1.180-150.0	4039784727731	130	1800	420	12	215,00
-------------------	-------------	---------------	-----	------	-----	----	--------



K 3 HOME	1.601-821.0	4039784951129	120	1600	380	18	175,00
----------	-------------	---------------	-----	------	-----	----	--------



K 3	1.601-888.0	4054278897332	120	1600	380	18	140,00
-----	-------------	---------------	-----	------	-----	----	--------

K 2 Home	1.673-240.0	4054278249414	110	1400	360	18	140,00
----------	-------------	---------------	-----	------	-----	----	--------

K 2	1.673-220.0	4039784720053	110	1400	360	24	110,00
-----	-------------	---------------	-----	------	-----	----	--------

* I prezzi si intendono iva esclusa **Con funzione Boost

OUTDOOR CLEANING

IDROPULITRICI A FREDDO

LINEA COMPACT



Modello	Codice	Codice EAN	Pressione Max (bar)	Potenza (W)	Portata (l/h)	Pallet	LP 2022*
K 7 Compact	1.447-050.0	4054278438542	180	3000	600	12	485,00
K 5 Compact	1.630-750.0	4054278498041	145	2100	500	8	315,00
K 4 Compact	1.637-500.0	4054278497150	130	1800	420	8	240,00
K 3 Compact	1.676-200.0	4054278796154	120	1600	380	18	150,00
K 2 Compact	1.673-500.0	4054278451596	110	1400	360	24	95,00

LINEA EXTRA SMALL



K 2 Universal	1.673-000.0	4054278629889	110	1400	360	24	75,00
K Mini	1.600-054.0	4054278804712	110	1400	360	36	130,00

IDROPULITRICI A FREDDO CON MOTORE A SCOPPIO



Modello	Codice	Codice EAN	Pressione Max (bar)	Potenza (W)	Portata (l/h)	Pallet	LP 2022*
G 7.180	1.107-390.0	4054278527208	180	-	590	12	790,00

PULITRICE PORTATILE



Modello	Codice	Codice EAN	Pressione Max (bar)	Potenza (W)	Portata (l/h)	Pallet	LP 2022*
Pulitrice portatile a batteria Mobile Outdoor Cleaner OC 3	1.680-015.0	4054278636207	5	7,2 V	2	32	185,00

RIMUOVI GHIACCIO



Modello	Codice	Codice EAN	Batterie	Autonomia	Peso	Pallet	LP 2022*
Rimuovi ghiaccio EDI 4	1.598-900.0	4054278475110	2 x Li-Ion	15 min	540 g	32	65,00

SPAZZATRICI MANUALI



Modello	Codice	Codice EAN	Resa m ² /h	Ampiezza lavoro mm	Vano Raccogliitore	Pallet	LP 2022*
S 6 Twin	1.766-460.0	4054278247953	3000	860	38	8	390,00
S 6	1.766-420.0	4054278247946	2500	670	38	8	345,00
S 4 Twin	1.766-360.0	4054278247939	2400	680	20	21	160,00
S 4	1.766-320.0	4054278247922	1800	510	20	21	130,00

MANUTENZIONE SPAZI ESTERNI



Modello	Codice	Codice EAN	Potenza	Pallet	LP 2022*
PCL 4 Lavapatio	1.644-000.0	4054278505510	600 W	27	215,00

* I prezzi si intendono iva esclusa

GLI INDISPENSABILI

OUTDOOR CLEANING • ACCESSORI

TUBI & LANCE



Modello	Codice	Codice EAN	Compatibilità	Unità di vendita	Pezzi per Mastercarton	LP 2022*
Dispositivo sturatubi 7,5 m	2.637-729.0	4002667004496	Consigliato dalla classe 4	1	9	71,13
Dispositivo sturatubi 15 m	2.637-767.0	4002667005646	Consigliato dalla classe 4	1	9	94,49
TLA 4 Lancia telescopica per vetri e facciate	2.644-190.0	4054278684086	Tutti i modelli	1	1	137,48
Adattatore antitwist	■ 2.644-257.0	4054278825779	Tutti i modelli	1	10	21,00

* I prezzi si intendono iva esclusa ■ NEW

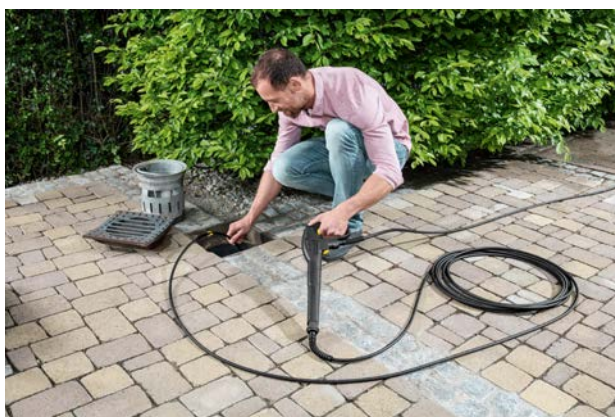

I dispositivi sturatubi liberano i condotti intasati nella maniera più semplice ed immediata utilizzando solamente l'acqua in alta pressione dell'idropulitrice.



La lancia telescopica consente di raggiungere le massime altezze alla tua idropulitrice fino a 5 m. Con il suo giunto snodabile fino a 180°, può arrivare ovunque.

Una selezione di accessori imprescindibili per potenziare la tua idropulitrice e ampliare le destinazioni d'uso.

OUTDOOR CLEANING • ACCESSORI

ACCESSORI PER LA PULIZIA DEI PAVIMENTI ESTERNI



Modello	Codice	Codice EAN	Compatibilità	Unità di vendita	Pezzi per Mastercarton	LP 2022*
Lavasuperfici T5	2.644-084.0	4054278513652	Da K 4 a K 7	1	1	87,19
Lavasuperfici T7 Plus	2.644-074.0	4054278633428	Da K 4 a K 7	1	1	121,23

* I prezzi si intendono iva esclusa

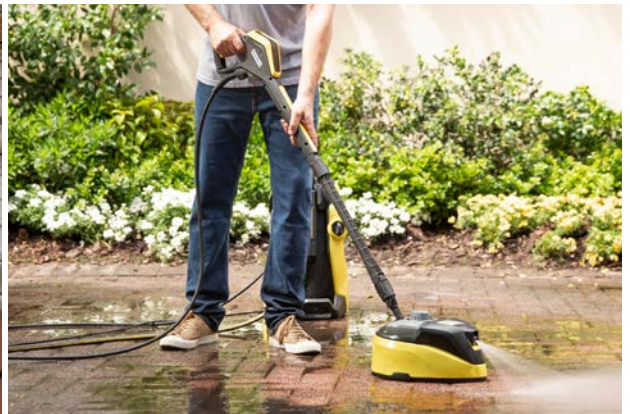

Le lavasuperfici sono indispensabili per pulire terrazze, pati e qualsiasi superficie all'esterno della casa. La versione T7 Plus ha anche un ugello in punta per una pulizia accurata anche negli angoli.

OUTDOOR CLEANING • ACCESSORI

ACCESSORI PER LA PULIZIA DELL'AUTO



Modello	Codice	Codice EAN	Compatibilità	Unità di vendita	Pezzi per Mastercarton	LP 2022*
Spazzola rotante WB 120	2.644-060.0	4054278476445	Tutti i modelli	1	11	44,20
Spazzola morbida cerchioni	2.643-234.0	4039784920736	Tutti i modelli	1	1	33,58





* I prezzi si intendono iva esclusa





Pulire in profondità la carrozzeria e i cristalli dell'auto sarà facile e anche divertente con la spazzola rotante WB 120. Basta collegarla all'idropulitrice e lasciare che le setole facciano il lavoro per te.

OUTDOOR CLEANING • ACCESSORI

PER COLLEGARE L'IDROPULITRICE ALLA RETE IDRICA

Modello	Codice	Codice EAN	Compatibilità	Unità di vendita	Pezzi per Mastercarton	LP 2022*
 Set collegamento idrico (tubo 10 m-1/2"; 2 raccordi portagomma da 1/2"-5/8"; 1 adattatore rubinetto)	2.645-258.0	4054278012780	Tutte le Idropulitrici	1	1	32,35
 Raccordo universale 1/2" - 5/8" - 3/4"	2.645-191.0	4039784605121	Tutte le Idropulitrici	15	15	3,84
 Tubo PrimoFlex 5/8" da 25 m	2.645-140.0	4039784447608	Tutte le Idropulitrici	1	1	26,26
 Carrello avvolgitubo HT 3.420. Con tubo PrimoFlex da 5/8" (20 m), lancia e raccordi	2.645-167.0	4039784523463	Tutte le Idropulitrici	6	6	70,15
 Avvolgitubo portatile HR 7.315 con cassetto portaoggetti. Con tubo PrimoFlex da 5/8" (15 m), lancia e raccordi	2.645-165.0	4039784523449	Tutte le Idropulitrici	1	1	78,24

PULIZIA SUPERFICI

 Lavasuperfici T 5	2.644-084.0	4054278513652	Da K 2 a K 7	1	1	87,19
 Lavasuperfici T 7 Plus	2.644-074.0	4054278633428	Da K 4 a K 7	1	1	121,23
 Paraspruzzi Splash guard	2.642-706.0	4039784608542	Da K 2 a K 7	1	1	22,91







SPAZZOLE & LANCE

 TLA 4 lancia telescopica per vetri e facciate	2.644-190.0	4054278684086	Da K 2 a K 7	1	1	137,48
 Spazzola per vetri e facciate (con TLA 4)	2.644-191.0	4054278684093	Da K 2 a K 7	1	1	52,49
 PS 30 Plus lavasuperfici	2.644-212.0	4054278713311	Da K 2 a K 7	1	1	54,44
 Spazzolone PS 30	2.644-123.0	4054278546858	Tutti i modelli	1	1	45,81
 Spazzola morbida universale WB 60	2.643-233.0	4039784920712	Tutti i modelli	1	7	26,38
 Spazzola rotante WB 130	■ 2.644-286.0	4054278476445	Tutti i modelli	1	11	44,20
 Unità intercambiabile universale per WB 130	■ 2.644-289.0	4054278476469	Tutti i modelli	1	8	12,10
 Attacco di ricambio Car & Bike per WB 130	■ 2.644-290.0	4054278476476	Tutti i modelli	1	8	25,59
 Attacco di ricambio per WB 130	■ 2.644-291.0	4054278476483	Tutti i modelli	1	8	10,81
 Spazzola Power morbida universale WB 150	2.643-237.0	4039784920941	Tutti i modelli	1	1	53,87
 Spazzola morbida cerchioni	2.643-234.0	4039784920736	Tutti i modelli	1	9	33,58
 Lancia Vario Power 120	2.642-724.0	4039784620179	max 120 bar	1	10	34,39
 Lancia Vario Power 145	2.642-725.0	4039784620186	max 145 bar	1	10	40,11
 Lancia Vario Power 180	2.642-726.0	4039784620193	max 180 bar	1	10	40,60
 Lancia Multi Jet 145 FC	2.643-906.0	4054278251035	max 145 bar	1	10	68,72
 Lancia Multi Jet 180 FC	2.643-907.0	4054278251028	max 180 bar	1	10	68,72
 Lancia Multi Power MP 145	2.643-239.0	4039784920972	max 145 bar	1	1	68,72
 Lancia Multi Power MP 160	2.643-238.0	4039784920958	max 160 bar	1	1	58,22





* I prezzi si intendono iva esclusa ■ NEW

OUTDOOR CLEANING • ACCESSORI





SPAZZOLE & LANCE

Modello	Codice	Codice EAN	Compatibilità	Unità di vendita	Pezzi per Mastercarton	LP 2022*
 Mini Lancia Vario Power 360° JS 160	2.643-254.0	4039784925588	max 160 bar	1	64	34,36
 Lancia mangiasporco db 120	2.642-727.0	4039784620209	max 120 bar	1	10	45,81
 Lancia mangiasporco db 145	2.642-728.0	4039784620216	max 145 bar	1	10	45,81
 Lancia mangiasporco db 180	2.642-729.0	4039784620223	max 180 bar	1	10	60,05
 Lancia angolare	2.638-817.0	4002667331448	max 160 bar	1	9	65,28
 Lancia prolunga 0,5 m	2.643-240.0	4039784920989	Tutti i modelli	1	10	18,39

TUBI & PROLUNGHE

 Kit Tubo (4 m) + Pistola Quick Connect	2.643-912.0	4054278252919	Tutti i modelli	1	9	50,31
 Kit Tubo (7,5 m) + Pistola Quick Connect	2.643-910.0	4054278257228	Tutti i modelli	1	7	59,83
 Kit Tubo (12 m) + Pistola Quick Connect	2.643-909.0	4054278251134	Tutti i modelli	1	6	71,15
 Tubo di ricambio alta pressione 9 m per macchine con Quick Connect	2.641-721.0	4039784361232	Tutti i modelli con Quick Connect	1	9	71,81
 Prolunga tubo alta pressione 10 m per macchine con Quick Connect	2.641-710.0	4039784296244	Tutti i modelli	1	9	95,66

ACCESSORI VARI

 Dispositivo sabbiatura	2.638-792.0	4002667331431	Consigliato dalla classe 4	1	9	78,41
 Dispositivo sturatubi 7,5 m	2.637-729.0	4002667004496	Consigliato dalla classe 4	1	9	71,13
 Dispositivo sturatubi 15 m	2.637-767.0	4002667005646	Consigliato dalla classe 4	1	9	94,49
 Dispositivo sturatubi 20 m e Kit pulizia grondaie	2.642-240.0	4039784523685	Consigliato dalla classe 4	1	1	113,95
 Filtro idrico	4.730-059.0	4002667011760	Tutti i modelli	1	30	17,22
 Tubo di aspirazione ecologic 5 m	2.643-100.0	4039784843080	Dalla classe 4 in su	1	5	28,82
 Set O-Ring attacco accessori idropulitrici	2.640-729.0	4039784051539	Tutti i modelli	1	10	13,74
 Giunto angolare	2.640-733.0	4039784051553	Tutti i modelli	1	10	29,40
 Schiumogeno 0,6 l	2.643-147.0	4039784855670	max 160 bar	1	8	21,32
 Schiumogeno Connect'n Clean Ultra Foam Edition (+1 l Ultra Foam)	2.643-143.0	4039784855632	max 160 bar	1	1	27,40
 Schiumogeno Connect'n Clean Car shampoo edition (+1 l Car Shampoo)	2.643-144.0	4039784855649	max 160 bar	1	1	27,40
 Adattatore	2.640-732.0	4039784051546	Tutti i modelli	1	10	13,12
Kit di pulizia parabrezza (con EDI4)	2.644-255.0	4054278818573	EDI4	1	1	22,30

* I prezzi si intendono iva esclusa

OUTDOOR CLEANING • ACCESSORI

ACCESSORI VARI



Modello	Codice	Codice EAN	Compatibilità	Unità di vendita	Pezzi per Mastercarton	LP 2022*
G 180 Q - Pistola di ricambio con aggancio Quick Connect	2.642-889.0	4039784664999	Tutti i modelli	1	1	38,29
G 160 - Pistola di ricambio con aggancio Clip	2.641-959.0	4039784418349	Tutti i modelli	1	1	26,84
G 145 Q - Pistola	2.643-634.0	4054278159812	K 4-7	1	10	85,92
G 180 Q - Pistola	2.643-992.0	4054278319889	K 5-7	1	10	111,79
Set rulli per pietra PCL 4	2.644-121.0	4054278564265	PCL 4	1	10	31,24
Caricabatterie OC 3 per auto	2.643-876.0	4054278243290	OC 3	1	24	26,72
Accessori box Adventure	2.643-857.0	4054278242200	OC 3	1	1	44,71
Accessori box Bike	2.643-858.0	4054278242415	OC 3	1	1	44,71
Accessori box Pet	2.643-859.0	4054278242422	OC 3	1	1	44,71
Caricabatteria da auto	2.644-250.0	4054278817521	EDI4 + Mobile Cleaner	1	10	19,95

OUTDOOR CLEANING • DETERGENTI WOW

DETERGENTE WOW











Modello	Codice	Codice EAN	Compatibilità	Unità di vendita	Pezzi per Mastercarton	LP 2022*
Car glass cleaner RM 650	6.296-105.0	4054278669090	Tutti i modelli	8	8	11,34
Interior cleaner RM 651	6.296-106.0	4054278669106	Tutti i modelli	8	8	10,98
Cockpit care matt finish RM 652	6.296-107.0	4054278669113	Tutti i modelli	8	8	13,67
Polish&Wax RM 660	6.296-108.0	4054278669120	Tutti i modelli	6	6	15,67
Winter screen wash concentrate RM 670	6.296-109.0	4054278669137	Tutti i modelli	1	1	23,69
Summer screen wash concentrate RM 672	6.296-110.0	4054278669144	Tutti i modelli	10	10	9,55



* I prezzi si intendono iva esclusa

OUTDOOR CLEANING • DETERGENTI





DETERGENTE FORMATO 1 L

Modello	Codice	Codice EAN	Compatibilità	Unità di vendita	Pezzi per Mastercarton	LP 2022*
 Detergente universale	6.295-753.0	4039784712133	Tutti i modelli	6	6	9,86
 Detergente per pietre e facciate	 6.295-765.0	4039784712300	Tutti i modelli	6	6	9,91
 Detergente per legno	 6.295-757.0	4039784712171	Tutti i modelli	6	6	8,61
 Detergente per superfici plastiche	 6.295-758.0	4039784712188	Tutti i modelli	6	6	9,62
 Detergente per auto e moto	 6.295-750.0	4039784712102	Tutti i modelli	6	6	9,63
 Detergente schiumogeno auto e moto	 6.295-743.0	4039784712034	Tutti i modelli	6	6	10,50
 Detergente per vetri e verande	 6.295-474.0	4039784917071	Tutti i modelli	6	6	9,54



DETERGENTE FORMATO 0,5 L

 Detergente per cerchi 3 in 1 500 ml - auto e moto	6.296-048.0	4054278529349	Tutti i modelli	1	8	11,88
 Detergente per rimozione insetti 3 in 1 - 500 ml - auto e moto	6.295-761.0	4039784712218	Tutti i modelli	1	8	9,16
 Detergente specifico per moto 3 in 1 - 500 ml	6.295-763.0	4039784712232	Tutti i modelli	1	8	8,33



DETERGENTE FORMATO 5 L

 Detergente universale RM 555	6.295-357.0	4039784359666	Tutti i modelli	1	1	18,80
 Detergente auto	6.295-360.0	4039784359697	Tutti i modelli	1	1	18,27
 Detergente pietre e facciate	6.295-359.0	4039784359680	Tutti i modelli	1	1	20,49
 Detergente legno	6.295-361.0	4039784359703	Tutti i modelli	1	1	20,18
 Detergente superfici plastiche	6.295-358.0	4039784359673	Tutti i modelli	1	1	19,41

DETERGENTE CONCENTRATO

 Detergente concentrato auto	6.295-843.0	4054278098722	Tutti i modelli	1	8	10,95
 Detergente concentrato pavimenti	6.295-842.0	4054278098715	Tutti i modelli	1	8	11,44

VARIE

 Sabbiane fino in sacco 25 kg	6.280-105.0	4002667001471	Tutti i modelli	1	1	24,80
 Bottiglia spray	6.394-374.0	4039784012684	Tutti i modelli	1	1	20,19

* I prezzi si intendono iva esclusa



HOME CLEANING: AD OGNUNO IL SUO

L'offerta di Kärcher è così ampia che consente di scegliere l'apparecchio più indicato alle proprie esigenze di pulito. La nuova gamma di **aspiratori multiuso**, ad esempio, vanta diverse dimensioni, funzionalità con performance di aspirazione imbattibili.

L'ampia gamma di accessori aumenta ulteriormente le loro destinazioni d'uso trasformandoli in veri e propri alleati del pulito.

Anche il comparto **Floor Cleaning** si rinnova ampliando la gamma con BR 30/1, una lavapavimenti professionale ideale per spazi fino a 200 m².

Un'offerta sempre più ampia per soddisfare i clienti più esigenti.



INDICE

HOME CLEANING

Aspiratori solido liquidi	22
Aspiratori aspiracenere e aspiracenere	22
Aspiratori lavamoquette-Lavapavimenti	23
Aspirapolvere	23
Aspirabriciole	23
Aspiragocce e Lavavetri a batteria ricaricabile	23
Lucidatrice	23

HOME CLEANING

Elettroscopa a batteria ricaricabile	23
Lavapavimenti	24
Pulitori a vapore	24
Pulitori a vapore con aspirazione	24
Accessori	25
Detergenti	31

UN MONDO DI MULTIFUNZIONALITÀ PER PERFORMANCE PROFESSIONALI

FUNZIONE SOFFIANTE

Disponibile su tutta
la gamma (tranne
su WD/KWD4).

FUNZIONE
SOFFIANTE



NEW

SACCHETTI IN VELLO

Su tutta la gamma. **Durano più del doppio** rispetto ai sacchetti in plastica e garantiscono una **maggiore filtrazione** delle polveri.



NEW

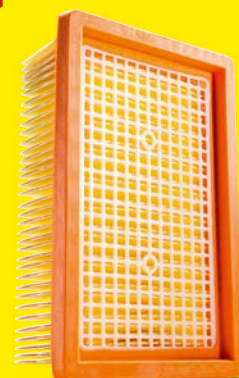

FILTRI EVOLUTI

Efficienti e pratici, trattengono efficacemente le polveri. Lo **scuotifiltro** mantiene i filtri sempre puliti per un'aspirazione perfetta.

La gamma di **Aspiratori solido liquidi** Kärcher si rinnova con modelli più capienti, più performanti e dalla potenza imbattibile.

HIGH SUCTION
POWER

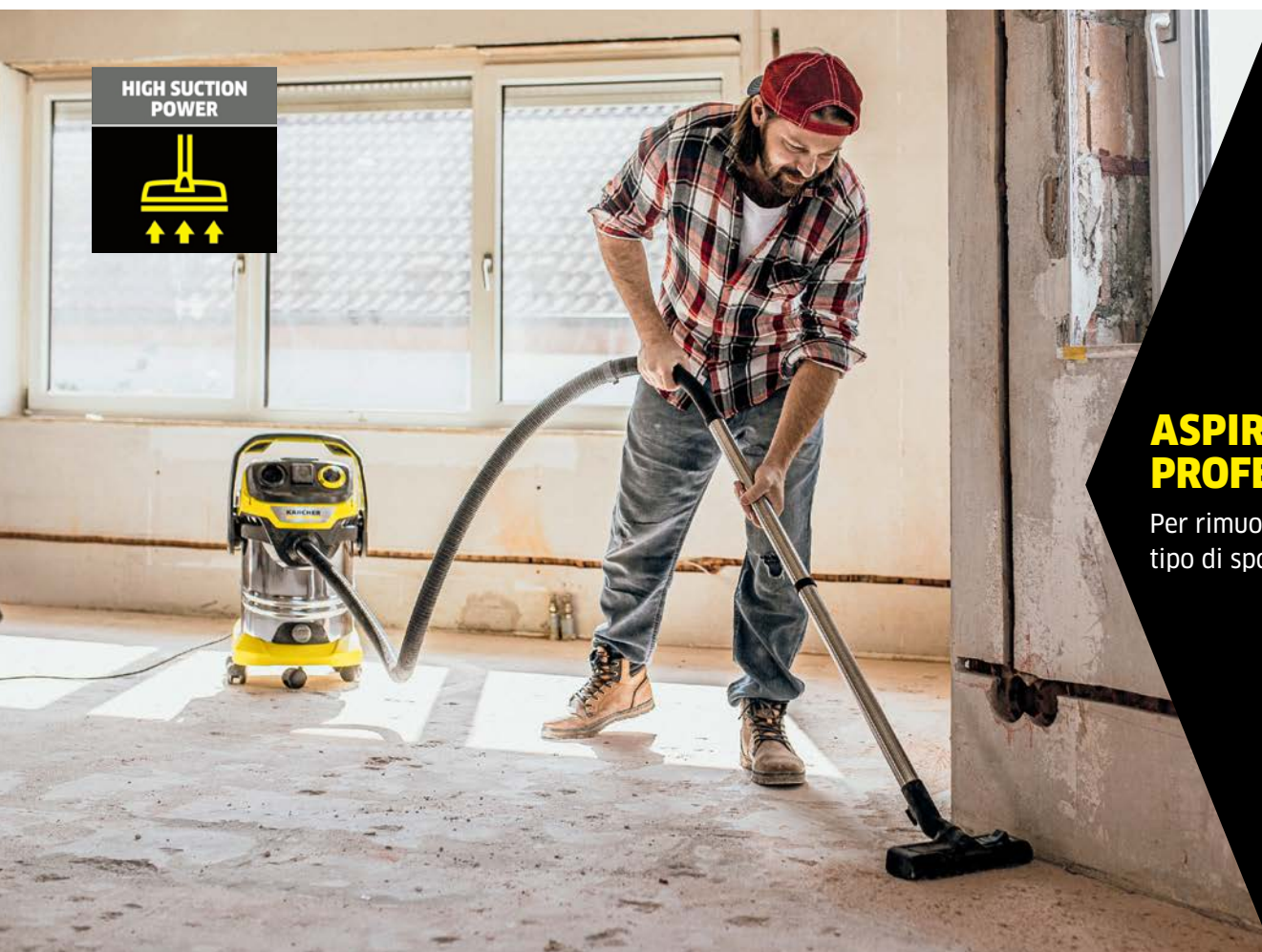

ASPIRAZIONE PROFESSIONALE

Per rimuovere qualsiasi tipo di sporco.

ASPIRAZIONE LIQUIDI

Anche in condizioni estreme e senza rimuovere il filtro.



PRESA ELETTROUTENSILE

Allacciamento compatibile con tutti gli elettroutensili.



WD 3: IL CAMPIONE D'ASPIRAZIONE IN TUTTO IL MONDO

Il nostro aspiratore solido liquidi più **iconico**, diffuso in tutto il mondo e **punto di riferimento della categoria**.

Oggi **WD3** è disponibile in una nuova veste, all'interno di un'ampia gamma con un **nuovo design, capacità più ampie e performance sempre al TOP**.

>1,2 Mio
UNITÀ VENDUTE
IN 1 ANNO

**BEST
SELLER
WORLDWIDE**



UNA GAMMA COMPLETA E TRASPARENTE A PARTIRE DAL NOME

Da oggi la nostra nuova gamma di aspiratori solido liquidi WD/ KWD è ancora più **riconoscibile**. Nel nome del prodotto sono infatti integrate delle informazioni essenziali relative alla **capacità, materiali, lunghezza cavo di alimentazione e tubo d'aspirazione**.

Ecco un esempio:

Modello di prodotto

P = Presa elettroutensile
S = Metallo

Info:

Tubi in acciaio
T = S. Tubes

Classe di prodotto

WD:2 Plus,3,4,5,6

Info:

Capacità fusto
30 = 30l

WD 6 P S V-30/8/22/T

Info:

V = Versione

Abbreviazione categoria di prodotto

WD = Wet&Dry
KWD = Kärcher Wet&Dry

Info:

Lunghezza tubo aspirazione
22 = 2,2m

Info:

Lunghezza cavo
8 = 8m





HOME CLEANING

ASPIRATORI SOLIDO LIQUIDI

	Modello	Codice	Codice EAN	P. Aspirante (Air Watt)	Consumo (W)	Capacità serbatoio (l)	Pallet	LP 2022*
	WD 6 P S V-30/6/22 T + DDC (per polveri di foratura)	1.628-382.0	4054278926421	260	1300	30	18	265,00
	KWD 6 P S V-30/8/22 T	1.628-486.0	4054278923482	260	1300	30	18	250,00
	WD 5 S V-30/5/22	1.628-379.0	4054278909233	240	1100	30	18	220,00
	WD 5 P S V-25/5/22 Workshop (allacciamento elettroutensile e spazzolina)	1.628-374.0	4054278876573	240	1100	25	18	245,00
	WD 5 P V-25/8/35	1.628-372.0	4054278876566	240	1100	25	18	220,00
	KWD 5 V-25/5/22	1.628-483.0	4054278908120	240	1100	25	18	185,00
	WD 4 S V-20/4/35	1.628-253.0	4054278661865	220	1000	20	24	150,00
	WD 4 V-20/5/22	1.628-201.0	4054278661001	220	1000	20	18	125,00
	WD 3 S V-19/6/20 Car	1.628-151.0	4054278923789	200	1000	19	24	140,00
	WD 3 S V-19/4/20	1.628-141.0	4054278656311	200	1000	19	24	105,00
	WD 3 P V-17/4/20	1.628-170.0	4054278656366	200	1000	17	24	110,00
	WD 3 V-19/4/20	1.628-107.0	4054278656083	200	1000	19	24	85,00
	WD 2 Plus S V-15/4/18	1.628-050.0	4054278656021	180	1000	15	30	95,00
	WD 2 Plus V-12/4/18	1.628-000.0	4054278655659	180	1000	12	36	70,00

ASPIRATORE ASPIRACENERE E ASPIRACENERE

	Modello	Codice	Codice EAN	Consumo (W)	Capacità serbatoio (l)	Pallet	LP 2022*
	AD 4 Premium	1.629-731.0	4054278242064	600	17	24	160,00
	AD 2	1.629-711.0	4054278242026	600	14	30	120,00

* I prezzi si intendono iva esclusa

HOME CLEANING

ASPIRATORI LAVAMOQUETTE-LAVAPAVIMENTI

Modello	Codice	Codice EAN	Depressione (mbar)	Consumo (W)	Capacità serbatoio (l)	Pallet	LP 2022*
SE 5.100	1.081-200.0	4039784515086	210	1400	4+4	24	375,00



ASPIRAPOLVERE

Modello	Codice	Codice EAN	Consumo (W)	Capacità serbatoio (l)	Pallet	LP 2022*
VC 6 Cordless ourFamily	1.198-660.0	4054278834221	140	-	56	350,00
VC 4 Cordless myHome	1.198-620.0	4054278834214	250	-	56	230,00
VC 5	1.349-100.0	4054278184357	500	0,2	72	190,00
VC 3	1.198-125.0	4054278206738	700	0,9	28	150,00
VC 2	1.198-105.0	4054278206714	700	2,8	30	150,00



ASPIRABRICIOLE

CVH 2	1.198-401.0	4054278899800	288	-	12	60,00
-------	-------------	---------------	-----	---	----	-------



ASPIRAGOCCE E LAVAVETRI A BATTERIA RICARICABILE

Modello	Codice	Codice EAN	Resa Lavoro	Durata batteria (min)	Capacità serbatoio (ml)	Pallet	LP 2022*
WV 6 Plus	1.633-510.0	4054278469546	300 m ²	100	150	42	100,00
WV 2 Plus N	1.633-212.0	4054278645575	75 m ²	35	100	42	70,00
WV 2 + KV4	1.633-218.0	4054278645605	75 m ²	25	100	42	130,00
KV 4 VibraPad (lavavetri)	1.633-920.0	4054278311821	100 m ²	35	180	40	80,00



LUCIDATRICE

Modello	Codice	Codice EAN	Resa Lavoro	Consumo (W)	Capacità serbatoio (l)	Pallet	LP 2022*
FP 303	1.056-820.0	4039784195769	1.000 giri/min	600 W	4 litri	16	230,00



ELETTROSCOPA A BATTERIA RICARICABILE

Modello	Codice	Codice EAN	Resa Lavoro	Durata batteria (min)	Capacità serbatoio	Pallet	LP 2022*
KB 5	1.258-000.0	4054278208312	-	30 min	0,4 litri	32	85,00



* I prezzi si intendono iva esclusa ■ NEW

HOME CLEANING

LAVAPAVIMENTI



Modello	Codice	Codice EAN	Resa Lavoro	Tempo di asciugatura	Capacità serbatoio	Pallet	LP 2022*
BR 30/1 C Bp Pack 18/25 ■	1.783-055.0	4054278834504	200 m ²	2 min	1000 ml	12	850,00
FC 7 Cordless	1.055-730.0	4054278540955	135 m ²	2 min	400 ml	21	520,00
FC 5 Cordless	1.055-601.0	4054278438344	60 m ²	2 min	400 ml	28	400,00
NEW FC 5	1.055-400.0	4054278516196	60 m ²	2 min	400 ml	28	265,00
EWM 2 ■	1.056-300.0	4054278872896	60 m ²	2 min	360 ml	36	190,00

PULITORI A VAPORE



Modello	Codice	Codice EAN	Pressione (bar)	Potenza (W)	Capacità serbatoio (l)	Pallet	LP 2022*
SC 5 EasyFix Iron Plug	1.512-530.0	4054278309484	4,2	2200	0,5-1,5	12	435,00
SC 4 EasyFix	1.512-450.0	4054278313023	3,5	2000	0,5-0,8	18	270,00
SC 3 Upright EasyFix	1.513-300.0	4054278290911	-	1600	0,5	72	180,00
SC 3 EasyFix	1.513-124.0	4054278312415	3,5	1900	1,0	24	190,00
SC 2 Upright EasyFix	1.513-345.0	4054278728452	-	1600	0,4	24	130,00
SC 2 EasyFix	1.512-050.0	4054278312491	3,2	1500	1,0	24	140,00
SC 1 EasyFix	1.516-330.0	4054278319094	3	1200	0,2	72	105,00
SI 4 EasyFix Iron Kit	1.512-462.0	4054278679877	4	2200	0,45-0,5	16	640,00





PULITORI A VAPORE CON ASPIRAZIONE

Modello	Codice	Codice EAN	Pressione (bar)	Potenza (W)	Capacità serbatoio (l)	Pallet	LP 2022*
SV 7	1.439-410.0	4039784998858	4	2200	0,45-0,5	16	710,00



* I prezzi si intendono iva esclusa ■ NEW

HOME CLEANING • ACCESSORI ASPIRATORI - ASPIRACENERE

SACCHETTI & FILTRI

Modello	Cont. Conf.	Codice	Codice EAN	Compatibilità	Unità di vendita	Pezzi per Mastercarton	LP 2022*
 Sacchetto filtro in carta	5 pz	2.863-297.0	4054278502946	WD 1 Compact Battery	1	58	12,13
 Sacchetto filtro in carta	5 pz	6.904-322.0	4039784059290	WD 2 (MV 2)	1	10	10,61
 Sacchetto filtro in vello	4 pz	2.863-314.0	4054278777689	WD 2-3	1	10	10,90
 Sacchetto filtro in vello	4 pz	2.863-006.0	4039784945241	WD 4-5-6 (MV 4-5-6)	1	10	13,37
 Sacchetto filtro in carta	5 pz	6.904-143.0	4002667015317	SE	1	1	21,68
 Filtro a cartuccia	1 pz	2.863-303.0	4054278598819	WD 1-3 (MV 2-3)	1	18	14,17
 Filtro plissettato piatto New System	1 pz	2.863-005.0	4039784945234	WD 4-5-6 (MV 4-5-6)	1	30	18,65
 Filtro plissettato piatto	1 pz	6.414-498.0	4002667015973	SE	1	15	14,50
 Filtro plissettato piatto per AD	1 pz	6.415-953.0	4039784729209	AD	1	1	22,24

SET

Modello	Cont. Conf.	Codice	Codice EAN	Compatibilità	Unità di vendita	Pezzi per Mastercarton	LP 2022*
 Drill Dust Catcher (per polveri foratura)	1 pz	2.863-234.0	4054278207414	Tutti i modelli WD (MV)	1	12	25,84
 Set pulizia interni auto	7 pz	2.863-225.0	4054278042107	Tutti i modelli WD (MV)	1	12	85,27
 Set interni casa (bocchetta commutabile + bocchetta imbottiture)	2 pz	2.863-002.0	4039784973343	Tutti i modelli WD (MV)	1	6	35,70
 Set per elettrodomestici	2 pz	2.863-112.0	4039784001596	Tutti i modelli WD (MV)	1	10	23,23

* I prezzi si intendono iva esclusa ■ NEW

HOME CLEANING • ACCESSORI ASPIRATORI - ASPIRACENERE

BOCCHETTE, SPAZZOLE & PROLUNGHE



Modello	Cont. Conf.	Codice	Codice EAN	Compatibilità	Unità di vendita	Pezzi per Mastercarton	LP 2022*
Bocchetta manuale per Lavamoquette - Lavapavimenti (SE)	1 pz	2.885-018.0	4039784359338	SE	1	1	27,73
Bocchetta lunga per cenere e polvere	1 pz	2.863-307.0	4054278656908	AD	1	12	13,45
Lancia bocchetta extra lunga	2 pz	2.863-306.0	4054278656892	Tutti i modelli WD (MV)	1	16	11,21





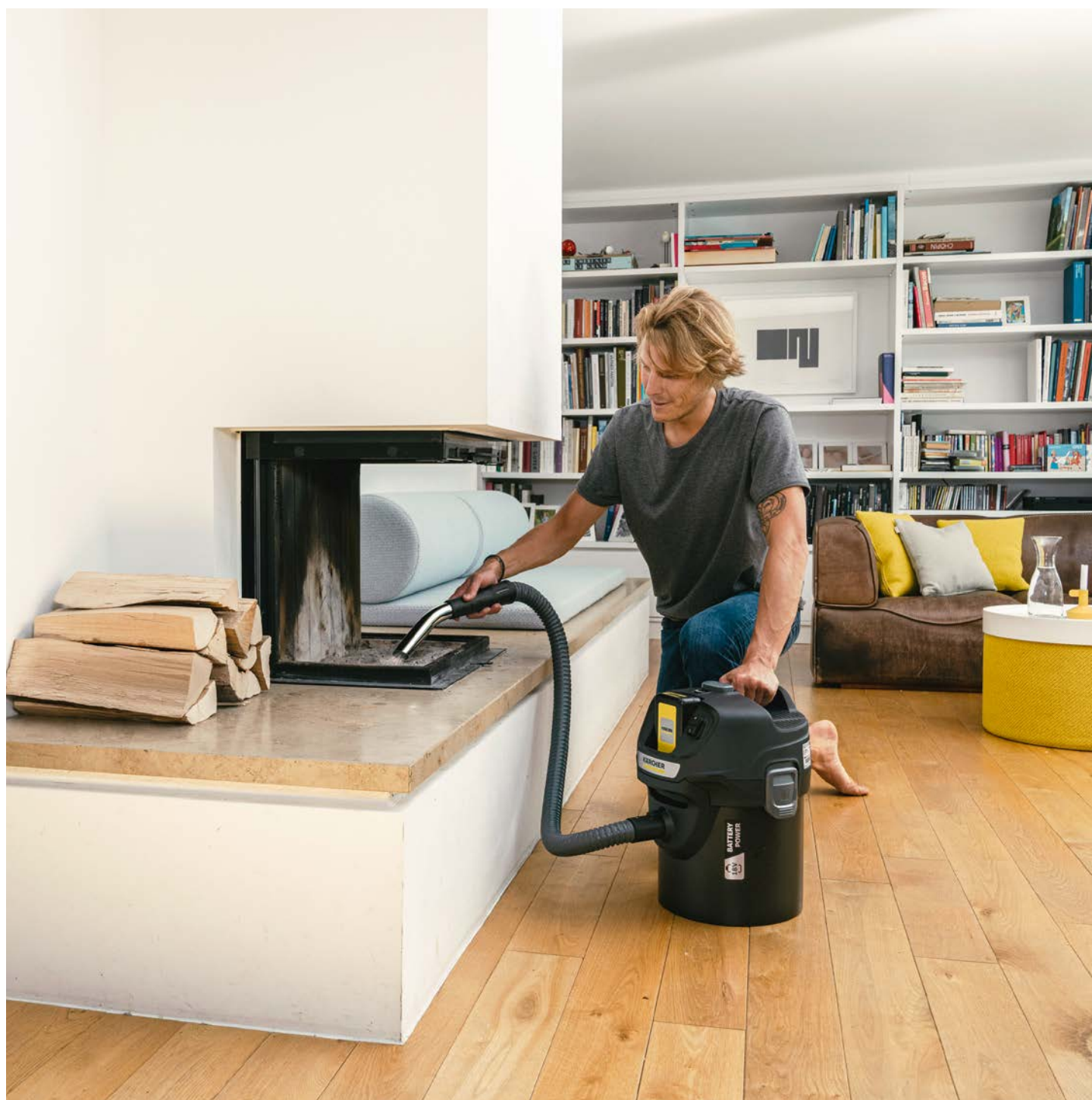

* I prezzi si intendono iva esclusa



HOME CLEANING • ACCESSORI ASPIRATORI - ASPIRACENERE

BOCCHETTE, SPAZZOLE & PROLUNGHE

	Modello	Cont. Conf.	Codice	Codice EAN	Compatibilità	Unità di vendita	Pezzi per Mastercarton	LP 2022*
	Bocchetta auto ■	1 pz	2.863-316.0	4039784045637	Tutti i modelli WD (MV) + SE	1	9	16,99
	Set spazzole aspirazione	1 pz	2.863-221.0	4039784048164	Tutti i modelli WD (MV) + SE	1	24	24,64
	Bocchetta commutabile secco umido	1 pz	2.863-000.0	4039784973336	Tutti i modelli WD (MV)	1	1	26,27
	Prolunga di aspirazione 3,5 m	1 pz	2.863-305.0	4039784960169	Tutti i modelli WD (MV) + SE	1	1	35,19
	Prolunga tubo dn 35	1 pz	2.863-308.0	4054278657813	Tutti i modelli WD (MV) + SE	1	12	18,05





ACCESSORI ASPIRAPOLVERE A TRAINO / COMPATTO

	Filtro Hepa 13 per VC 3	1 pz	2.863-238.0	4054278229683	VC 3	1	80	17,14
	Filtro Hepa 13 per VC 2	1 pz	2.863-237.0	4054278229676	VC 2	1	90	9,90
	Sacchetti filtro per VC 2	1 pz	2.863-236.0	4054278229652	VC 2	1	32	13,23
	Filtro a cartuccia per VC 5	1 pz	2.863-239.0	4054278240985	VC 5	1	36	15,93
	Filtro Hepa (EN 1822:1998) per VC 5	1 pz	2.863-240.0	4054278240992	VC 5	1	30	12,19
	Spazzola morbida per VC 5	1 pz	2.863-241.0	4054278241005	VC 5	1	30	12,19













* I prezzi si intendono iva esclusa ■ NEW

HOME CLEANING • ACCESSORI

ACCESSORI LUCIDATRICE

	Modello	Cont. Conf.	Codice	Codice EAN	Compatibilità	Unità di vendita	Pezzi per Mastercarton	LP 2022*
	Pads - spazzole universali	3 pz	2.863-193.0	4039784363458	FP 303	1	20	25,04
	Pads - spazzole superfici morbide (parquet)	3 pz	2.863-196.0	4039784404106	FP 303	1	30	30,89
	Pads - spazzole superfici semi morbide (parquet e laminati)	3 pz	2.863-197.0	4039784404113	FP 303	1	30	30,89
	Pads - spazzole superfici dure (pvc, marmo, linoleum)	3 pz	2.863-198.0	4039784404120	FP 303	1	30	30,89
	Sacchetti filtro carta	3 pz	6.904-128.0	4002667013399	FP 303	1	10	11,11

ACCESSORI ASPIRAGOCCE A BATTERIA RICARICABILE

	Panni in microfibra	2 pz	2.633-100.0	4039784379725	Tutti WV	1	16	14,37
	Labbra in gomma per bocchetta grande (280 mm)	2 pz	2.633-005.0	4039784518735	Tutti WV	1	50	11,18
	Labbra in gomma per bocchetta piccola (170 mm)	2 pz	2.633-104.0	4039784535985	Tutti WV	1	50	12,73
	Bocchetta di aspirazione piccola (170 mm)	1 pz	2.633-002.0	4039784518926	WV 51-50 Classic	1	36	17,57
	Bocchetta di aspirazione piccola (170 mm)	1 pz	2.633-112.0	4039784917811	WV 5 - WV 2	1	45	16,61
	Set prolunga	1 pz	2.633-144.0	4054278544830	Tutti WV	1	1	42,95
	Set stazione + batteria	1 pz	2.633-116.0	4039784990661	WV 5	1	12	51,84
	Batteria intercambiabile	1 pz	2.633-123.0	4054278018140	WV 5	1	12	29,98
	Caricabatteria	1 pz	2.633-107.0	4039784824003	Tutti WV	1	10	20,81
	Set flacone spray Premium	1 pz	2.633-129.0	4054278238227	Tutti WV	1	18	18,78
	Panno in microfibra per interni con velcro	2 pz	2.633-130.0	4054278238234	Tutti WV PREMIUM	1	20	11,91
	Panno in microfibra per esterni con velcro	2 pz	2.633-131.0	4054278238241	Tutti WV PREMIUM	1	-	14,81

* I prezzi si intendono iva esclusa

HOME CLEANING • ACCESSORI











ACCESSORI PULITORI A VAPORE

	Modello	Cont. Conf.	Codice	Codice EAN	Compatibilità	Unità di vendita	Pezzi per Mastercarton	LP 2022*
	Set panni usa e getta	15 pz	2.863-299.0	4054278516349	SC EasyFix	1	12	8,38
	Set panni microfibra EasyFix per bagno	4 pz	2.863-266.0	4054278315942	SC EasyFix	1	16	40,47
	Set panni microfibra per bocchetta	2 pz	2.863-259.0	4054278317076	SC EasyFix	1	16	22,53
	Set panni microfibra EasyFix per cucina	4 pz	2.863-265.0	4054278315935	SC EasyFix	1	16	40,47
	Coperture in microfibra per spazzola tonda grande	2 pz	2.863-243.0	4054278235646	SC EasyFix	1	30	18,36
	2 Panni abrasivi in microfibra	2 pz	2.863-309.0	4054278661032	SC EasyFix	1	24	20,77
	Set panni microfibra	2 pz	2.863-270.0	4054278317274	Tutti SC, SI e SV	1	16	19,06
	2 Panni pavimento e 3 Panni bocchetta manuale	5 pz	6.960-019.0	4002667012576	SC serie 3-2-1	1	12	18,06
	Prolunga e ugello power	1 pz	2.863-263.0	4054278315911	Tutti SC e SI	1	15	10,89
	Ugello power	1 pz	2.863-159.0	4039784060142	Tutti SC e SI	1	36	25,62
	Ugello a getto puntiforme	1 pz	4.130-431.0	4039784444645	Tutti SC e SI	1	1	7,28
	Bocchetta vetri	1 pz	2.863-025.0	4054278180502	Tutti SC e SI	1	12	17,44
	Bocchetta manuale	1 pz	2.884-280.0	4039784048065	Tutti SC e SI	1	12	18,82
	Bocchetta per abiti	1 pz	2.863-233.0	4054278167398	Tutti SC e SI	1	20	14,34
	Spazzola tonda grande	1 pz	2.863-022.0	4054278042732	Tutti SC e SI	1	10	14,34
	Set spazzoline tonde	4 pz	2.863-264.0	4054278315928	Tutti SC e SI	1	15	11,66

* I prezzi si intendono iva esclusa

HOME CLEANING • ACCESSORI

VARIE

Modello	Cont. Conf.	Codice	Codice EAN	Compatibilità	Unità di vendita	Pezzi per Mastercarton	LP 2022*
 Set spazzoline tonde	4 pz	2.860-231.0	4039784149304	SV	1	15	22,36
 Set spazzoline ottone	3 pz	2.863-061.0	4002667015577	tutti SC e SI	1	15	13,92
 Filtro Hepa 12	1 pz	2.860-229.0	4039784149298	SV	1	15	36,42
 Tubo prolunga	1 pz	2.863-021.0	4054278031491	SC 1	1	14	23,50
 Iron EasyFinish	1 pz	2.863-310.0	4054278660981	SC 5; SI	1	1	119,70
 Asse da stiro aspirante - soffiante	1 pz	2.884-933.0	4039784194809	SC 5-4 con ferro da stiro	1	1	333,03
 Copri asse da stiro	1 pz	2.884-969.0	4039784205390	Asse da stiro	1	15	35,28
 Kit EasyFix	1 pz	2.863-267.0	4054278317083	Tutti SC e SI	1	14	36,74
 Set panni microfibra per bocchetta	2 pz	2.863-259.0	4054278317076	SC EasyFix	1	16	22,53
 Supporto tappeti	1 pz	2.863-269.0	4054278317106	SC EasyFix	1	18	17,89

ACCESSORI LAVAPAVIMENTI

 Set rulli gialli in microfibra	1 pz	2.055-006.0	4054278237541	Tutti gli FC	1	24	27,65
 Set rulli grigi in microfibra	1 pz	2.055-007.0	4054278237558	Tutti gli FC	1	24	27,65
 Set rulli in microfibra per pavimenti in pietra	1 pz	2.055-021.0	4054278522265	Tutti gli FC	1	24	33,18

* I prezzi si intendono iva esclusa

HOME CLEANING • DETERGENTI

DETERGENTI



Modello	Cont. Conf.	Codice	Codice EAN	Compatibilità	Unità di vendita	Pezzi per Mastercarton	LP 2022*
Detergente per vetri concentrato	0,5 l	6.295-772.0	4039784716155	Tutti WV	8	8	7,64
Detergente per vetri concentrato	4 x 20 ml	6.295-302.0	4039784342033	Tutti WV	20	20	6,11
RM 511 Decalcificante biologico sticks	Sticks	6.295-987.0	4039784205956	Tutti SC	15	15	9,18
Filtro decalcificante	1 pz	2.863-018.0	4054278026213	SC 3	1	12	14,89
Antischiuma neutro	125 ml	6.295-873.0	4054278054360	SV	6	6	9,36
Antischiuma profumazione fruttata	125 ml	6.295-875.0	4054278054391	SV	6	6	11,80
RM 762 Caretex	0,5 l	6.295-769.0	4039784712645	SE	8	8	34,78
Detergente per Moquette/Tappeti RM 519	1 l	6.295-771.0	4039784712669	SE	6	6	11,53
Detergente base per Pietra/Linoleum/PVC RM 533	1 l	6.295-775.0	4039784716186	FP 303	6	6	10,01
Cera per pavimenti Pietra/Linoleum/PVC RM 532	1 l	6.295-776.0	4039784716193	FP 303	6	6	17,73
Cera per parquet laminati RM 531	1 l	6.295-777.0	4039784716209	FP 303	6	6	17,64
Cera per parquet RM 530	1 l	6.295-778.0	4039784716216	FP 303	6	6	17,63
Detergente per parquet RM 534	0,5 l	6.295-941.0	4054278197791	FC 5	8	8	12,99
Detergente per parquet con cera RM 535	0,5 l	6.295-942.0	4054278212302	FC 5	8	8	13,29
Detergente per pavimenti in pietra RM 537	0,5 l	6.295-943.0	4054278212319	FC 5	8	8	13,61
Detergente universale per pavimenti RM 536	0,5 l	6.295-944.0	4054278212326	FC 5	8	8	11,90

* I prezzi si intendono iva esclusa



GARDEN: LA QUALITÀ NON È ACQUA

Se c'è da drenare acqua dalla cantina allagata o dal piccolo stagno in giardino non dobbiamo più preoccuparci di quale elettropompa sommersa scegliere. La SP 5 Dual è adatta sia per acque chiare che per acque scure. Affidabile ed efficiente, è dotata, come tutta la gamma SP, dell'anello di tenuta in ceramica che garantisce la massima sicurezza e durata nel tempo: **5 anni di garanzia!**

Ci siamo impegnati a migliorare anche i nostri sistemi di irrigazione, alzando la qualità ed offrendo **lance e pistole per ogni necessità**. Il vostro giardino è in pendenza? Kärcher propone irrigatori con puntali che li ancorano al terreno. Vogliamo rendere il giardinaggio un hobby davvero piacevole. Per questo abbiamo pensato a nuovi disegni di irrigazione e abbiamo inventato il **primo raccordo antigoccia**.

Fai la differenza con Kärcher.

INDICE

GARDEN

Elettropompe	33
Accessori	34
Irrigazione	35

GARDEN • ELETTOPOMPE

ELETTROPOMPE SOMMERSE

5
ANNI
GARANZIA



Modello	Codice	Codice EAN	Portata (l/h)	Prevalenza/pressione max. (mt/bar)	Potenza (W)	Pallet	LP 2022*
SP 7 Dirt Inox	1.645-506.0	40 54278 06045 3	15500	8/0,8	750	39	220,00
SP 7 Dirt	1.645-504.0	40 54278 06043 9	15500	8/0,8	750	39	175,00
SP 6 Flat Inox	1.645-505.0	40 54278 06044 6	14000	9/0,9	550	39	205,00
SP 5 Dual	1.645-580.0	4054278304915	9500	7/0,7	500	42	155,00
SP 5 Dirt	1.645-503.0	40 54278 06042 2	9500	7/0,7	500	60	125,00
SP 3 Dirt	1.645-502.0	40 54278 06041 5	7000	6/0,6	350	60	90,00
SP 2 Flat	1.645-501.0	40 54278 05940 2	6000	5/0,5	250	80	80,00
SP 1 Dirt	1.645-500.0	40 54278 05939 6	5500	4,5/0,45	250	60	70,00

ELETTROPOMPE DOMESTICHE CASA & GIARDINO



BP 5 Casa&Giardino	1.645-355.0	40 39784 69776 8	6.000	4,8 bar	1000	18	360,00
BP 3 Casa&Giardino	1.645-353.0	40 39784 69774 4	3.300	4 bar	800	18	245,00
BP 3 Casa	1.645-365.0	40 54278 03147 7	3.000	3,6 bar	800	16	200,00
BP 3 Giardino	1.645-351.0	40 39784 69772 0	3.500	4 bar	800	40	125,00
BP 2 Giardino	1.645-350.0	40 39784 69709 6	3.000	3,5 bar	700	40	115,00
BP 6 per pozzi	1.645-422.0	40 39784 87331 5	5.000	5,5 bar	1000	40	375,00
BP 4 per pozzi	1.645-421.0	40 39784 87330 8	4.600	4,3 bar	700	50	305,00
BP 2 per cisterne	1.645-420.0	40 39784 87329 2	5.700	3,2 bar	800	96	250,00
BP 1 per barili	1.645-460.0	40 39784 29283 3	3.800	1,1 bar	400	60	100,00

* I prezzi si intendono iva esclusa

GARDEN • ACCESSORI ELETTROPOMPE











TUBI, FILTRI, ADATTATORI & RACCORDI

	Modello	Codice	Codice EAN	Compatibilità	Unità di vendita	Pezzi per Mastercarton	LP 2022*
	Kit aspirazione 3,5 metri	2.997-110.0	4054278309170	Domestiche-Casa&Giardino tranne BP6 - 4 deep well BP2 cistern	1	6	32,94
	Tubo di aspirazione da sorgente 0,5 metri	6.997-360.0	4039784223271	Domestiche-Casa&Giardino tranne BP6 - 4 deep well BP2 cistern	1	10	13,08
	Filtro di aspirazione con antiriflusso, 3/4"	6.997-345.0	4039784221727	Domestiche-Casa&Giardino tranne BP6 - 4 deep well BP2 cistern	1	10	13,42
	Filtro di aspirazione con antiriflusso, 1"	6.997-342.0	4039784221734	Domestiche-Casa&Giardino tranne BP6 - 4 deep well BP2 cistern	1	10	14,02
	Filtro di aspirazione con valvola di non ritorno versione metallo 3/4" + 1"	6.997-341.0	4039784221741	Domestiche-Casa&Giardino tranne BP6 - 4 deep well BP2 cistern	1	10	28,34
	Pre-filtro. portata fino a 3000 l/h	6.997-343.0	4039784221758	Domestiche-Casa&Giardino tranne BP6 - 4 deep well BP2 cistern	1	15	35,97
	Pre-filtro. portata fino a 6000 l/h	2.997-211.0	4054278309996	Domestiche-Casa&Giardino tranne BP6 - 4 deep well BP2 cistern	1	15	50,60
	Pre-filtro	2.997-201.0	4054278133195	SP5 - 3 - 2 - 1	1	11	20,19
	Raccordo tubo d'aspirazione 3/4" a 1"	6.997-359.0	4039784223264	Domestiche Casa&Giardino SP5 - 3 - 1	1	20	7,94
	Set allacciamento pompa	6.997-358.0	4039784223257	Domestiche Casa&Giardino	1	10	5,02
	Set allacciamento pompa Premium	6.997-340.0	4039784221772	Domestiche Casa&Giardino	1	-	9,52
	Pressostato elettronico con protezione da funzionamento a secco	6.997-357.0	4039784223240	Solo BP 6 - 4 - 3 - 2	1	20	122,67
	Protezione da funzionamento a secco	6.997-355.0	4039784223226	Solo BP 6 - 4 - 3 - 2	1	20	103,16
	Regolatore di pressione 3/4" lunghezza 1 m	2.997-125.0	4054278309972	Solo Domestiche Casa&Giardino BP5 - 3	1	12	18,64
	Set tubo piatto	2.997-100.0	4054278133638	Max 5 Bar di pressione	1	10	45,78
	Raccordo di collegamento G1	6.997-473.0	4039784921924	Tutti i modelli	1	12	4,32
	Raccordo di collegamento per 2 uscite G1	6.997-474.0	4039784921931	Tutti i modelli	1	10	4,82

* I prezzi si intendono iva esclusa

GARDEN • IRRIGAZIONE

CARRELLI AVVOLGITUBO

Modello	Codice	Codice EAN	Unità di vendita	Pezzi per Mastercarton	LP 2022*
 Sella portatubo	2.645-044.0	4039784289260	10	10	5,53
 Sella portatubo Plus	2.645-161.0	4039784523401	4	4	11,61
 Avvolgitubo portatile HR 7.315 con cassetto portaoggetti. Dotato di tubo PrimoFlex da 5/8" (15 metri), lancia e raccordi	2.645-165.0	4039784523449	1	1	78,24
 Carrello avvolgitubo HT 3.420. dotato di tubo PrimoFlex da 5/8" (20 metri), lancia e raccordi	2.645-167.0	4039784523463	6	6	70,15
 Carrello avvolgitubo HT 4.520. dotato di tubo PrimoFlex da 1/2" (20 metri), lancia e raccordi	2.645-168.0	4039784523470	6	6	73,79
 Carrello avvolgitubo HT 4.520. dotato di tubo PrimoFlex da 5/8" (20 metri), lancia e raccordi	2.645-169.0	4039784523487	6	6	79,33
 Carrello avvolgitubo HT 4.500 dotato di raccordi	2.645-170.0	4039784523494	6	6	55,37
 Carrello avvolgitubo in metallo HT 80	2.645-042.0	4039784289246	1	1	86,14
 Compact Reel CR 3.110 balcony	2.645-210.0	4039784606630	4	4	53,41
 Compact Reel CR 7.220 automatic da parete	2.645-218.0	4039784615847	1	1	164,58



* I prezzi si intendono iva esclusa

GARDEN • IRRIGAZIONE

TUBI DA GIARDINO

Modello	Codice	Codice EAN	Unità di vendita	Pezzi per Mastercarton	LP 2022*
 Tubo PrimoFlex 5/8" da 25 metri	2.645-140.0	4039784447608	1	1	26,26
 Tubo PrimoFlex 5/8" da 50 metri	2.645-141.0	4039784447615	1	1	52,86
 Tubo PrimoFlex 3/4" da 25 metri	2.645-142.0	4039784447622	1	1	39,77
 Tubo PrimoFlex 3/4" da 50 metri	2.645-143.0	4039784447639	1	1	79,40
 Tubo Performance Plus 5/8" da 25 metri	2.645-320.0	40542785037210	1	1	37,06
 Tubo Performance Plus 5/8" da 50 metri	2.645-321.0	4054278503738	1	1	73,21
 Tubo Performance Plus 3/4" da 25 metri	2.645-322.0	4054278503981	1	1	54,56
 Tubo Performance Plus 3/4" da 50 metri	2.645-323.0	4054278503998	1	1	107,34
 Tubo Performance Premium 5/8" da 25 metri	2.645-326.0	4054278504025	1	1	57,20
 Tubo Performance Premium 5/8" da 50 metri	2.645-327.0	4054278504032	1	1	112,92

LANCE & PISTOLE

 Idropistola	2.645-265.0	4054278047409	10	10	9,79
 Idropistola multifunzione	2.645-266.0	4054278047515	9	9	11,12
 Lancia regolabile	2.645-267.0	4054278047522	14	14	7,91
 Idropistola plus	2.645-268.0	4054278047539	10	10	18,47
 Idropistola multifunzione plus	2.645-269.0	4054278047546	8	8	26,12
 Idropistola Premium metal	2.645-270.0	4054278047553	10	10	24,77
 Idropistola multifunzione Premium metal	2.645-271.0	4054278047560	8	8	32,81













* I prezzi si intendono iva esclusa

GARDEN • IRRIGAZIONE

LANCE & PISTOLE

Modello	Codice	Codice EAN	Unità di vendita	Pezzi per Mastercarton	LP 2022*
 Lancia	2.645-264.0	4054278047393	10	10	4,69
Lancia (Sfusa)	2.645-272.0	4054278047577	20	20	3,73
 Lancia con prolunga	2.645-157.0	4039784521247	8	8	15,74
 Lancia con prolunga Plus	2.645-158.0	4039784521261	8	8	18,54
 Lancia con prolunga Premium	2.645-137.0	4039784426368	8	8	22,41
 Doccia da giardino basamento treppiede	2.645-181.0	4039784579903	3	3	36,40
 Supporto a parete per doccia	2.645-182.0	4039784579934	6	6	7,47















RACCORDI, CONNETTORI & PRESE RUBINETTO

 Raccordo universale 1/2" - 5/8" - 3/4"	2.645-191.0	4039784605121	15	15	3,84
 Raccordo universale 1/2" - 5/8" - 3/4" - sfuso	2.645-201.0	4039784604469	25	25	3,00
 Raccordo universale 1/2" - 5/8" - 3/4" con aquastop	2.645-192.0	4039784605138	15	15	3,73
 Raccordo universale 1/2" - 5/8" - 3/4" con aquastop - sfuso	2.645-202.0	4039784604476	25	25	3,50
 Raccordo universale Plus 1/2" - 5/8" - 3/4"	2.645-193.0	4039784605145	15	15	4,19
 Raccordo universale Plus 1/2" - 5/8" - 3/4" - sfuso	2.645-203.0	4039784604506	25	25	4,79
 Raccordo universale Plus con aquastop 1/2" - 5/8" - 3/4"	2.645-194.0	4039784605152	15	15	5,64
 Raccordo universale Plus con aquastop 1/2" - 5/8" - 3/4" - sfuso	2.645-204.0	4039784605039	25	25	5,39
 Raccordo universale Premium 1/2" - 5/8" - 3/4"	2.645-195.0	4039784605046	15	15	6,15
 Raccordo universale Premium con aquastop 1/2" - 5/8" - 3/4"	2.645-196.0	4039784605060	15	15	6,53
 Raccordo riparatore universale 1/2" - 5/8" - 3/4"	2.645-197.0	4039784605077	15	15	3,21
 Raccordo riparatore universale 1/2" - 5/8" - 3/4" - sfuso	2.645-207.0	4039784605107	25	25	3,00
 Raccordo tubo con valvola di regolazione	2.645-198.0	4039784605084	15	15	9,45

* I prezzi si intendono iva esclusa

GARDEN • IRRIGAZIONE

RACCORDI, CONNETTORI & PRESE RUBINETTO

Modello	Codice	Codice EAN	Unità di vendita	Pezzi per Mastercarton	LP 2022*
 Presa rubinetto da 3/4" con riduzione da 1/2"	2.645-006.0	4039784288874	15	15	2,11
 Presa rubinetto da 3/4" con riduzione da 1/2" - sfusa	2.645-065.0	4039784346888	25	25	1,78
 Presa rubinetto da 1" con riduzione da 3/4"	2.645-007.0	4039784288881	15	15	3,20
 Presa rubinetto da 1" con riduzione da 3/4" - sfusa	2.645-066.0	4039784346895	25	25	2,43
 Congiunzione a 2 vie	2.645-008.0	4039784288898	10	10	2,50
 Congiunzione a 2 vie - sfusa	2.645-067.0	4039784346901	25	25	1,73
 Congiunzione a 3 vie	2.645-009.0	4039784288904	15	15	3,79
 Presa rubinetto per rubinetti domestici	2.645-010.0	4039784288911	12	12	5,99
 Presa rubinetto 2 vie	2.645-199.0	4039784620254	10	10	9,45
 Presa rubinetto 3 vie	2.645-200.0	4039784620261	4	4	22,27
 Raccordo utensili con filetto da 1/2"	2.645-098.0	4039784368460	15	15	1,73
 Raccordo utensili con filetto da 3/4"	2.645-099.0	4039784368477	15	15	2,11
 Set o-ring	2.645-074.0	4039784348530	15	15	2,50
 Set guarnizioni	2.645-073.0	4039784348523	15	15	1,73
 Adattatore rubinetto	2.645-256.0	4039784998957	10	10	6,24

* I prezzi si intendono iva esclusa

GARDEN • IRRIGAZIONE

GAMMA OTTONE

Modello	Codice	Codice EAN	Unità di vendita	Pezzi per Mastercarton	LP 2022*
 Congiunzione a 2 vie in ottone	2.645-100.0	4039784368484	10	10	4,53
 Congiunzione a 3 vie in ottone	2.645-101.0	4039784368491	10	10	7,08
 Preso rubinetto in ottone da 3/4" con riduzione da 1/2"	2.645-013.0	4039784288942	10	10	4,91
 Preso rubinetto da 1" in ottone	2.645-014.0	4039784288959	10	10	4,91
 Raccordo in ottone 1/2", 5/8"	2.645-015.0	4039784288973	10	10	6,73
 Raccordo in ottone 3/4"	2.645-016.0	4039784288980	10	10	8,46
 Raccordo in ottone 1/2" - 5/8" con aquastop	2.645-017.0	4039784288997	10	10	7,77
 Raccordo in ottone 3/4" con aquastop	2.645-018.0	4039784289000	10	10	9,33
 Riparatore in ottone 1/2" - 5/8"	2.645-102.0	4039784368507	10	10	7,22
 Riparatore in ottone 3/4"	2.645-103.0	4039784368514	10	10	10,80
 Lancia in ottone	2.645-054.0	4039784289383	10	10	8,61

SET & KIT

Modello	Codice	Codice EAN	Unità di vendita	Pezzi per Mastercarton	LP 2022*
 Set raccordi 1/2", 5/8"	2.645-176.0	4039784538009	10	10	4,97
 Set idropistola e raccordi	2.645-289.0	4054278113623	8	8	16,49
 Set lancia e raccordi	2.645-288.0	4054278113616	16	16	10,52
 Set idropistola multifunzione e raccordi plus	2.645-290.0	4054278113630	7	7	33,34
 Set di collegamento al rubinetto	2.645-122.0	4039784372405	5	5	10,02

* I prezzi si intendono iva esclusa

GARDEN • IRRIGAZIONE

SET & KIT

Modello	Codice	Codice EAN	Unità di vendita	Pezzi per Mastercarton	LP 2022*
Kit: tubo PrimoFlex da 1/2" (15 metri), sella portatubo, lancia e raccordi	2.645-114.0	4039784371279	1	1	33,97
Kit: tubo PrimoFlex da 1/2" (20 metri), pistola e raccordi	2.645-115.0	4039784371286	1	1	35,01
Kit tubo spiralato 10 m base	2.645-179.0	4039784575042	3	3	28,02
Kit tubo spiralato 10 m completo pistola multifunzione	2.645-178.0	4039784561953	3	3	32,06
Set collegamento idrico (tubo 10m-1/2"; 2 raccordi portagomma da 1/2"-5/8; 1 adattatore rubinetto)	2.645-258.0	4054278012780	1	1	32,35

IRRIGATORI

Modello	Codice	Codice EAN	Unità di vendita	Pezzi per Mastercarton	LP 2022*
Irrigatore rotante RS 130/3	2.645-019.0	4039784289024	8	8	17,58
Irrigatore rotante RS 120/2	2.645-020.0	4039784289031	8	8	15,47
Irrigatore oscillante OS 3.220	2.645-133.0	4039784426337	6	6	20,74
Irrigatore oscillante OS 5.320 S	2.645-134.0	4039784426344	6	6	36,97
Irrigatore oscillante OS 5.320 SV	2.645-135.0	4039784426351	6	6	50,67
Irrigatore pulsante PS 300	2.645-023.0	4039784289062	10	10	21,00
Irrigatore circolare su puntale CS 90	2.645-024.0	4039784289079	10	10	6,66
Irrigatore circolare CS 90 vario	2.645-025.0	4039784289086	10	10	6,66
Irrigatore multifunzione MS 100, 6 getti	2.645-026.0	4039784289093	8	8	11,52

















CENTRALINE & TIMER

Modello	Codice	Codice EAN	Unità di vendita	Pezzi per Mastercarton	LP 2022*
Senso Timer ST 6 Duo ecologic	2.645-214.0	4039784610514	3	3	185,96
Senso Timer ST 6 ecologic	2.645-213.0	4039784610507	3	3	133,14
Centralina irrigazione WT 5	2.645-219.0	4039784629950	3	3	70,68
Centralina irrigazione WT 4	2.645-174.0	4039784535008	3	3	40,47
Timer Irrigazione WT 2	2.645-209.0	4039784620278	3	3	34,46
Sensori di ricambio	2.645-242.0	4039784921177	15	15	8,77

* I prezzi si intendono iva esclusa

GARDEN • IRRIGAZIONE

KÄRCHER RAIN SYSTEM™ - KRS®

Modello	Codice	Codice EAN	Unità di vendita	Pezzi per Mastercarton	LP 2022*
 Filtro protezione	2.645-225.0	4039784919709	6	6	7,99
 Riduttore di pressione incluso filtro	2.645-226.0	4039784919693	6	6	12,03
 Tubo	2.645-227.0	4039784919723	42	42	14,90
 Tubo poroso 25 m	2.645-228.0	4039784919730	10	10	33,33
 Tubo poroso 10 m	2.645-229.0	4039784919747	10	10	17,22
 Connettore a T con regolatore di portata	2.645-231.0	4039784919624	10	10	9,13
 Connettore in linea	2.645-232.0	4039784919648	20	20	5,22
 Tappo di fine linea	2.645-233.0	4039784919655	10	10	5,22
 Gocciolatore	2.645-234.0	4039784919662	10	10	7,96
 Anello riparatore	2.645-235.0	4039784919679	10	10	5,73
 Micro irroratore	2.645-236.0	4039784919686	10	10	13,01
 Puntale	2.645-237.0	4039784919716	16	16	5,19
 Set micro Irroratori	2.645-239.0	4039784919761	9	9	34,64
 Set tubo	2.645-240.0	4039784919778	7	7	22,36
 Set tubo poroso	2.645-241.0	4039784919785	10	10	43,06
 KRS® Set irrigazione vasi	2.645-276.0	40 54278 05478 0	3	3	46,56

* I prezzi si intendono iva esclusa



INDICE

PRODOTTI A BATTERIA

Prodotti a batteria 18V	44
Prodotti a batteria 36V	45
Caricabatterie	46
Accessori	47

PRODOTTI A BATTERIA 18V

IDROPISTOLA

Modello	Codice	Codice EAN	Pressione Max (bar)	Portata (l/h)	Batteria V/Ah	Pallet	LP 2022*
 KHB 6 Battery	1.328-010.0	4054278636740	24	200	18/25-50 (non incl.)	112	150,00

ASPIRATORE SOLIDO LIQUIDI

Modello	Codice	Codice EAN	P. Aspirante (Air Watt)	Capacità serbatoio (l)	Batteria V/Ah	Pallet	LP 2022*
 WD 1 Compact Battery	1.198-300.0	4054278353036	45	7	18/25-50 (non incl.)	18	120,00



ASPIRACENERE

Modello	Codice	Codice EAN	P. Aspirante (Air Watt)	Capacità serbatoio (l)	Batteria V/Ah	Pallet	LP 2022*
 AD 2 Battery	1.348-300.0	4054278662060	-	14	18/25-50 (non incl.)	24	160,00

RIMUOVI ERBACCE

Modello	Codice	Codice EAN	Spazzola (mm)	Materiale	Batteria V/Ah	Pallet	LP 2022*
 WRE 18-55	1.445-244.0	4054278693637	18-55	Nylon	18/25-50 (non incl.)	32	140,00

SOFFIATORE

Modello	Codice	Codice EAN	Velocità aria (km/h)	Portata aria (m³/h)	Batteria V/Ah	Pallet	LP 2022*
 BLV 18-200 Battery (soffiante / aspirante)	1.444-100.0	4054278548401	200/130	150/330	18/25-50 (non incl.)	-	225,00
 LBL 2 Battery	1.445-100.0	4054278459837	210/-	220/-	18/25-50 (non incl.)	27	90,00

RASAERBA

Modello	Codice	Codice EAN	Ampiezza di taglio (cm)	Altezza di taglio (mm)	Batteria V/Ah	Pallet	LP 2022*
 LMO 18-33 Battery	1.444-400.0	4054278543291	33	35-65	18/50 (non incl.)	18	210,00
LMO 18-36 Battery	1.444-420.0	4054278546940	36	30-70	18/50 (non incl.)	9	320,00

REGOLABORDI

Modello	Codice	Codice EAN	Diametro taglio (cm)	Spessore filo (mm)	Batteria V/Ah	Pallet	LP 2022*
 LTR 18-25 Battery	1.444-300.0	4054278548975	25	1,6	18/25-50 (non incl.)	-	85,00
LTR 18-30 Battery	1.444-310.0	4054278550237	30	1,6	18/25-50 (non incl.)	32	110,00

TAGLIASIEPI

Modello	Codice	Codice EAN	Lunghezza di taglio (cm)	Spaziatura denti (mm)	Batteria V/Ah	Pallet	LP 2022*
 HGE 18-45 Battery	1.444-230.0	4054278546902	45	18	18/25-50 (non incl.)	-	110,00
HGE 18-50 Battery	1.444-240.0	4054278550428	50	22	18/25-50 (non incl.)	32	140,00

TAGLIASIEPI TELESCOPICO

Modello	Codice	Codice EAN	Lunghezza di taglio (cm)	Spaziatura denti (mm)	Batteria V/Ah	Pallet	LP 2022*
 PHG 18-45 Battery	1.444-210.0	4054278547978	45	18	18/25-50 (non incl.)	-	150,00

TAGLIAERBA

Modello	Codice	Codice EAN	Lungh. taglio lama arbusti (cm)	Spaziatura denti (mm)	Batteria V/Ah	Pallet	LP 2022*
 GSH 18-20 Battery	1.444-200.0	4054278547985	20	10	18/25-50 (non incl.)	108	110,00

DIFFUSORE

Modello	Codice	Codice EAN			Batteria V/Ah	Pallet	LP 2022*
 PSU 4-18 Diffusore	1.445-300.0	4054278886060	-	-	18/25-50 (non incl.)	-	85,00

ELETTROPOMPA DA BARILE

Modello	Codice	Codice EAN			Batteria V/Ah	Pallet	LP 2022*
 BP 2.000-18 Pompa da barile	1.645-475.0	4054278878102	-	-	18/25-50 (non incl.)	-	85,00

* I prezzi si intendono iva esclusa

PRODOTTI A BATTERIA 18V

SEGHETTO TELESCOPICO



Modello	Codice	Codice EAN	Lunghezza lama (cm)	Velocità rotaz. catena m/s	Batteria V/Ah	Pallet	LP 2022*
PSW 18-20 Battery	1.444-010.0	4054278548944	20	5.5	18/25-50 (non incl.)	18	150,00

TRONCARAMI



Modello	Codice	Codice EAN	Potenza del taglio (Nm)	Lunghezza di taglio (cm)	Batteria V/Ah	Pallet	LP 2022*
TLO 18-32 Battery	1.444-020.0	4054278548944	250	85	18/25-50 (non incl.)	-	195,00

ELETTROSEGA



Modello	Codice	Codice EAN	Lunghezza di taglio (cm)	Velocità catena (m/s)	Batteria V/Ah	Pallet	LP 2022*
CNS 18-30 Battery	1.444-001.0	4054278548937	30	10	18/25-50 (non incl.)	18	225,00

PRODOTTI A BATTERIA 36V

IDROPULITRICE



Modello	Codice	Codice EAN	Pressione Max (bar)	Portata (l/h)	Batteria V/Ah	Pallet	LP 2022*
K 2 Battery	1.117-200.0	4054278305158	110	340	36/50 (non incl.)	18	215,00

ASPIRATORE SOLIDO LIQUIDI



Modello	Codice	Codice EAN	P. Aspirante (Air Watt)	Capacità serbatoio (l)	Batteria V/Ah	Pallet	LP 2022*
WD 3 Battery Premium	1.629-950.0	4054278291864	67	17	36/25-50 (non incl.)	24	165,00
WD 3 Battery	1.629-910.0	4054278287393	67	17	36/25-50 (non incl.)	24	140,00

SOFFIATORE



Modello	Codice	Codice EAN	Velocità aria (km/h)	Portata aria (m³/h)	Batteria V/Ah	Pallet	LP 2022*
BLV 36-240 Battery	1.444-170.0	4054278548401	240/130	300/770	36/25-50 (non incl.)	27	260,00
LBL 4 Battery	1.445-150.0	4054278459899	250/-	330/-	36/25-50 (non incl.)	27	140,00



RASAERBA



Modello	Codice	Codice EAN	Ampiezza di taglio (cm)	Altezza di taglio (mm)	Batteria V/Ah	Pallet	LP 2022*
LMO 36-40 Battery	1.444-452.0	4054278661797	40	20-70	36/50 (non incl.)	6	410,00
LMO 36-46 Battery	1.444-472.0	4054278661803	46	20-70	36/50 (non incl.)	4	515,00

REGOLABORDI



Modello	Codice	Codice EAN	Diametro taglio (cm)	Spessore filo (mm)	Batteria V/Ah	Pallet	LP 2022*
LTR 36-33 Battery	1.444-350.0	4054278549255	33	2.0	36/25-50 (non incl.)	24	150,00

TAGLIASIEPI



Modello	Codice	Codice EAN	Lunghezza taglio (cm)	Spaziatura denti (mm)	Batteria V/Ah	Pallet	LP 2022*
HGE 36-60 Battery	1.444-250.0	4054278550459	60	26	36/25-50 (non incl.)	32	205,00

ELETTROSEGA



Modello	Codice	Codice EAN	Lunghezza taglio (cm)	Velocità catena (m/s)	Batteria V/Ah	Pallet	LP 2022*
CNS 36-35 Battery	1.444-050.0	4054278548968	35	21	36/25-50 (non incl.)	-	280,00

* I prezzi si intendono iva esclusa

BATTERIE + CARICABATTERIE RAPIDI

STARTER KIT



Modello	Codice	Codice EAN	Piattaforma (V)	Amperaggio (Ah)	Unità di vendita	Pezzi per Mastercarton	LP 2022*
Battery Power 18/25 + 18 V Fast Charger	2.445-062.0	4054278650364	18	2,5	1	4	106,31
Battery Power 18/50 + 18 V Fast Charger	2.445-063.0	4054278650371	18	5,0	1	4	142,01
Battery Power 36/25 + 36 V Fast Charger	2.445-064.0	4054278650388	36	2,5	1	4	190,84
Battery Power 36/50 + 36 V Fast Charger	2.445-065.0	4054278650395	36	5,0	1	4	255,16

BATTERIE ACCESSORIE



Modello	Codice	Codice EAN	Piattaforma (V)	Amperaggio (Ah)	Unità di vendita	Pezzi per Mastercarton	LP 2022*
Battery Power 18/25	2.445-034.0	4054278511740	18	2,5	1	6	70,09
Battery Power 18/50	2.445-035.0	4054278511757	18	5,0	1	6	127,65
Battery Power 36/25	2.445-030.0	4054278543161	36	2,5	1	6	139,13
Battery Power 36/50	2.445-031.0	4054278509037	36	5,0	1	6	199,67

CARICABATTERIE RAPIDI





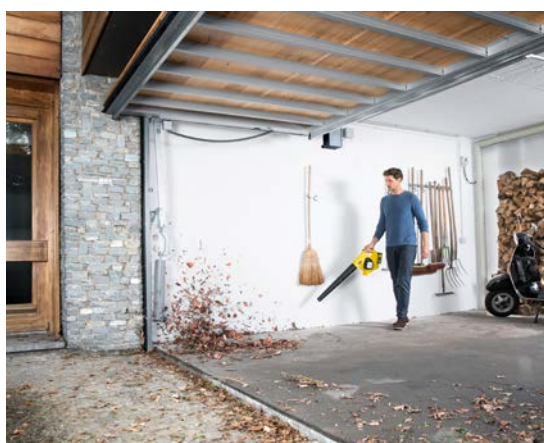

























Modello	Codice	Codice EAN	Piattaforma (V)	Amperaggio (Ah)	Unità di vendita	Pezzi per Mastercarton	LP 2022*
18 V Fast Charger Battery Power	2.445-032.0	4054278509044	18	2,5 / 5,0	1	9	46,44
36 V Fast Charger Battery Power	2.445-033.0	4054278509051	36	2,5 / 5,0	1	9	64,05



ACCESSORI PER PRODOTTI A BATTERIA

ACCESSORI

	Modello	Codice	Codice EAN	Compatibilità	Unità di vendita	Pezzi per Mastercarton	LP 2022*
	Spazzolone ps 20	2.644-018.0	4054278338217	KHB 5-6 battery	1	1	45,10
	Tubo prolunga	2.644-173.0	4054278650357	KHB 5-6 battery	1	12	13,26
	FJ 24 schiumogeno	2.644-135.0	4054278588315	KHB 5-6 battery	1	8	22,98
	WB 24 spazzola	2.644-136.0	4054278588322	KHB 5-6 battery	1	9	28,43
	SH 5 tubo autoadescente	2.644-124.0	4054278549279	KHB 5-6 battery	1	5	29,33
	Bocchetta auto	2.863-316.0	4039784045637	WD 1 Compact Battery	1	9	16,99
	Set spazzole aspirazione (x2)	2.863-221.0	4054278042060	WD 1 Compact Battery	1	24	24,64
	Sacchetto filtro in carta (x5)	2.863-297.0	4054278502946	WD 1 Compact Battery	1	58	12,13
	Filtro a cartuccia	2.863-303.0	4002667347937	WD 1-3 Battery	1	18	14,17
	Set interni casa (Bocchetta commutabile + bocchetta imbottiture)	2.863-002.0	4039784973343	WD 3 Battery	1	6	35,70
	Set pulizia interni auto	2.863-225.0	4054278042107	WD 3 Battery	1	12	85,27
	Sacchetto filtro in vell ■	2.863-314.0	4054278777689	WD 2-3 Battery	1	10	10,90
	Stringa di spazzole	2.445-243.0	4054278715643	WRE Battery	1	12	11,32
	Bretella di supporto	2.445-242.0	4054278600758	WRE Battery / BLV 18/36-200/ 240 Battery / PHG 18-45 Battery	1	8	19,16
	Lama 36 cm rasaerba	2.444-011.0	4054278571638	LMO 18-36 Battery	1	10	21,81
	Lama 33 cm rasaerba	2.444-010.0	4054278571621	LMO 18-33 Battery	1	10	21,81
	Lama 46 cm rasaerba	2.444-013.0	4054278572086	LMO 36-46 Battery	1	10	32,73
	Lama 40 cm rasaerba	2.444-012.0	4054278572031	LMO 36-40 Battery	1	10	32,73
	Filo bobina regolabordi	2.444-014.0	4054278571652	LTR 18 Battery	1	5	8,96
	Filo bobina regolabordi (pack x 2)	2.444-016.0	4054278571669	LTR 18 Battery	1	10	21,81
	Filo bobina regolabordi	2.444-015.0	4054278572048	LTR 36 Battery	1	5	11,34
	Filo bobina regolabordi (pack x 2)	2.444-017.0	4054278572055	LTR 36 Battery	1	10	27,29
	Lama per regolabordi (pack x 2)	2.444-022.0	4054278572062	LTR Battery	1	5	22,76
	Catena per seghetto	2.444-018.0	4054278571706	PSW 18-20 Battery	1	100	25,10
	Catena per elettrosega	2.444-019.0	4054278571690	CNS 18-30 Battery	1	100	28,39
	Catena per elettrosega	2.444-020.0	4054278572079	CNS 36-35 Battery	1	100	33,72
	SH 5 tubo autoadescente	2.643-100.0	4039784843080	K 2 BATTERY	1	5	28,82
	WB 120 spazzola rotante	2.644-060.0	4054278476445	K 2 BATTERY	1	11	44,20
	PS 30 spazzolone lavasuperfici	2.644-123.0	4054278546858	K 2 BATTERY	1	1	45,81

* I prezzi si intendono iva esclusa ■ NEW



CONDIZIONI GENERALI DI FORNITURA KÄRCHER SPA

VALIDITÀ

Le presenti condizioni annullano e sostituiscono le precedenti. Kärcher SpA si riserva la facoltà di apportare, in qualsiasi momento, modifiche ai Prodotti e/o ai loro prezzi.

PREZZI

Sono espressi in valuta (Euro) e si intendono I.V.A. esclusa. Il presente listino annulla e sostituisce il precedente. Eventuale Eco-Contributo RAEE è già incluso.

ORDINI E TRASPORTO

Gli ordini/proposte d'ordine pervenuti dalla Clientela saranno valutati con la clausola "salvo accettazione". Ci riserviamo la facoltà di accettare, rifiutare o modificare le proposte d'ordine. L'accettazione sarà esplicitata con conferma d'ordine. I valori minimi per ciascuna proposta d'ordine sono:

Ordine minimo per Macchine, Detergenti e Accessori Consumer	Valore	Porto franco
Ordine minimo	250 €	250 €

Tutte le macchine, accessori Consumer e detergenti e batterie sono gestiti con stock in Italia e spedizione tramite FM logistics.

Ordine minimo per Ricambi e Accessori professionali	Valore	Contributo di trasporto	Porto franco
Ordine minimo	100 €	10 €	250 €

Tutti i ricambi e gli accessori professionali sono gestiti con spedizione diretta da Germania e spediti tramite GLS

TERMINI DI CONSEGNA

I termini di consegna sono puramente indicativi e sono ipotizzati in 7 gg. lavorativi dal ricevimento dell'ordine; l'evasione di ciascun Ordine è in ogni caso subordinata alla disponibilità del magazzino e alla possibilità di fabbricazione, senza alcuna garanzia di copertura totale. La mancata consegna, parziale o totale, dei Prodotti non può dar luogo a rivalsa o richiesta di risarcimento danni.

RECLAMI/RESI

Eventuali reclami vanno comunicati su apposito modulo, da inoltrare al Customer Service del canale di competenza. Eventuali resi devono essere preventivamente autorizzati dalla sede Kärcher.

La versione integrale delle presenti Condizioni di Vendita e la relativa modulistica sono pubblicate all'indirizzo www.karcher-infonet.com

KÄRCHER

makes a difference

Siamo un'azienda orientata al cliente che si pone l'obiettivo di "fare la differenza". Grazie a soluzioni e tecnologie innovative, creiamo valore per i clienti, i dipendenti e la società.

Lavorare con entusiasmo e competenza.
Tradurre con efficacia le strategie in azioni.
Migliorare giorno dopo giorno,
per raggiungere gli obiettivi condivisi.
Adottare un comportamento responsabile,
rispettando le persone, i beni comuni e l'ambiente.

Fai la differenza con Kärcher.

Per informazioni



www.karcher.it
info@it.karcher.com



Kärcher S.p.A.
Via A. De Gasperi, 98/100
20017 Rho (MI)



Servizio Assistenza Clienti

NUMERO GIALLO
02-40702964

Orari: Lun-Sabato 8,00 - 20,00
(festivi esclusi)